

ELS
VESTITS

el mocador de cap

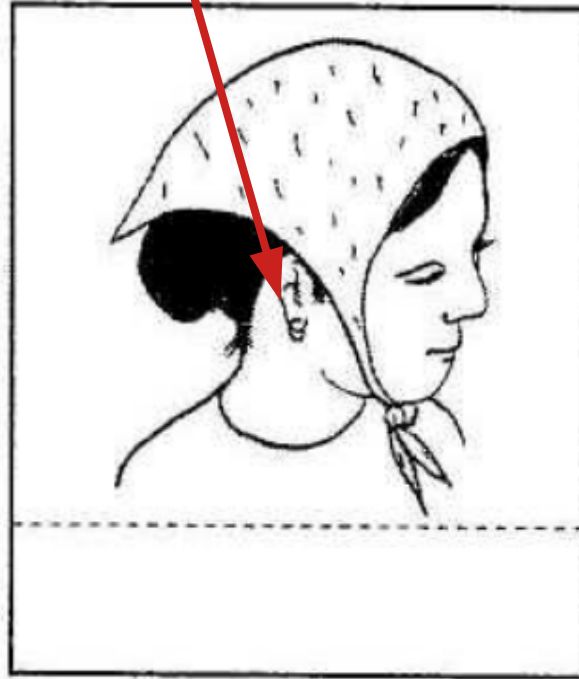

l'arracada



el pijama

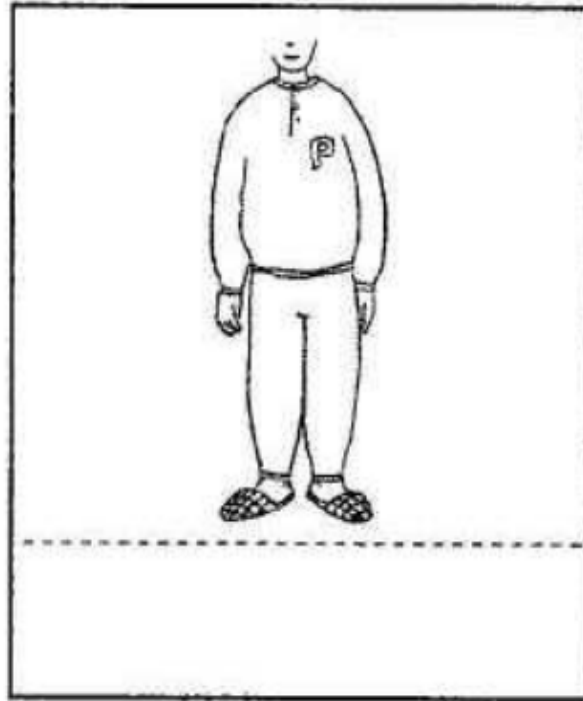

les sabatilles

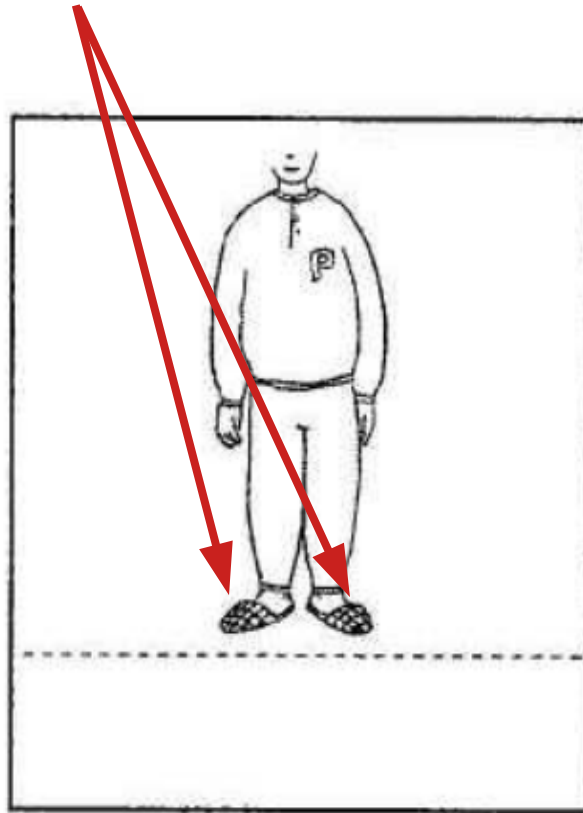

les sandàlies

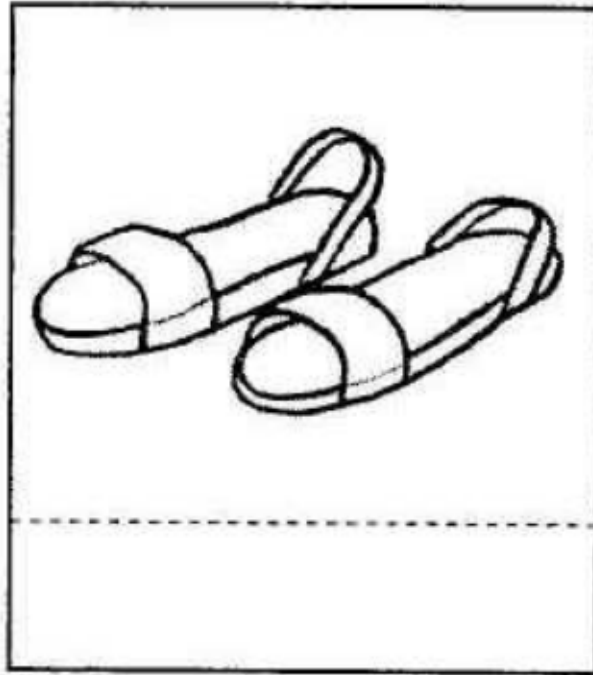

les sabates

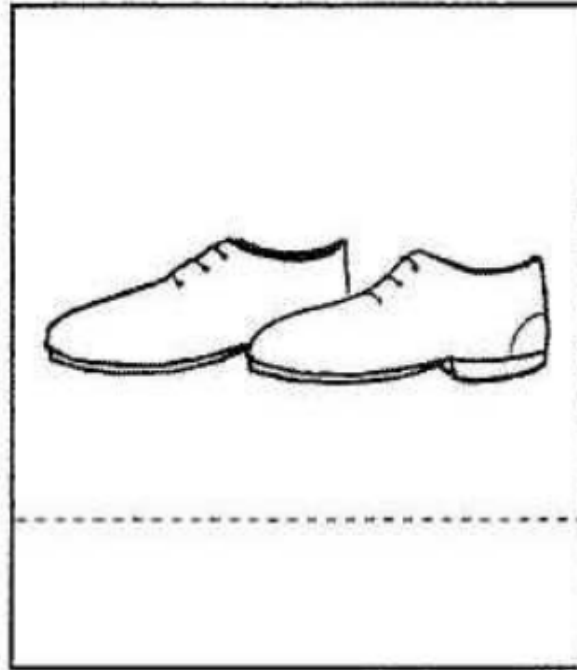

els cordons

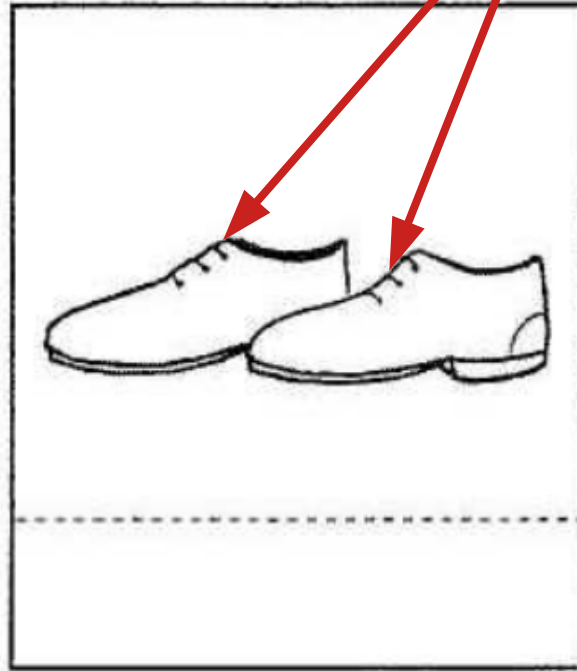

la sola

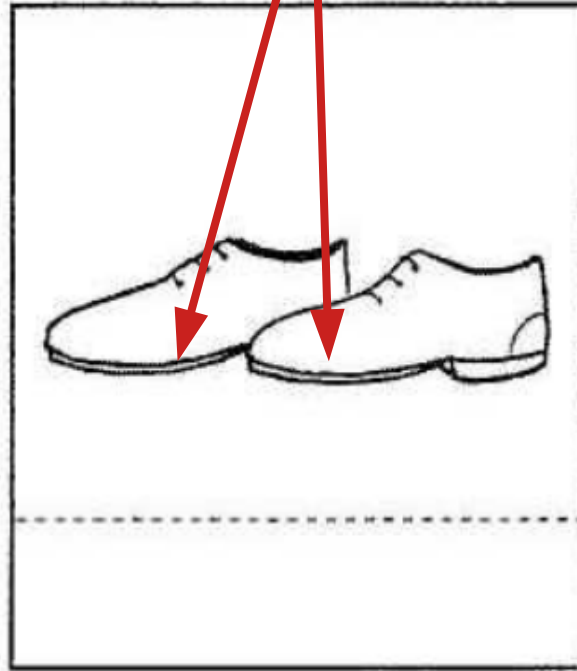

les sabatilles d'esport

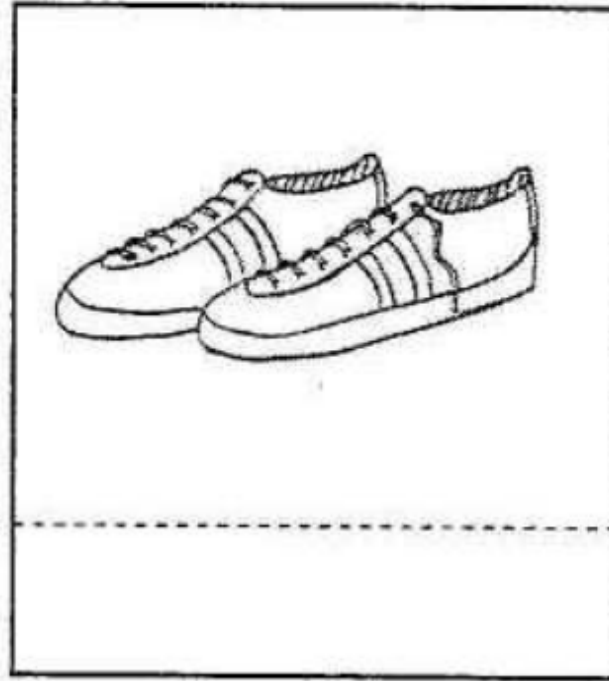

roba interior: els calçotets

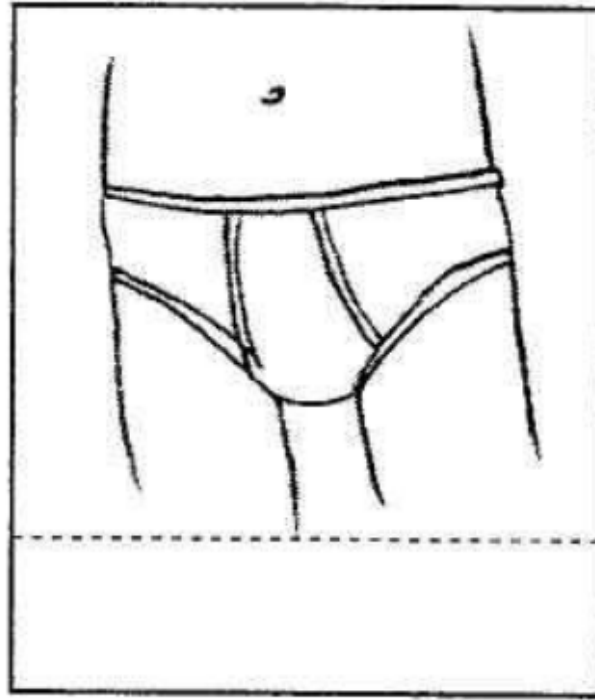

les calces

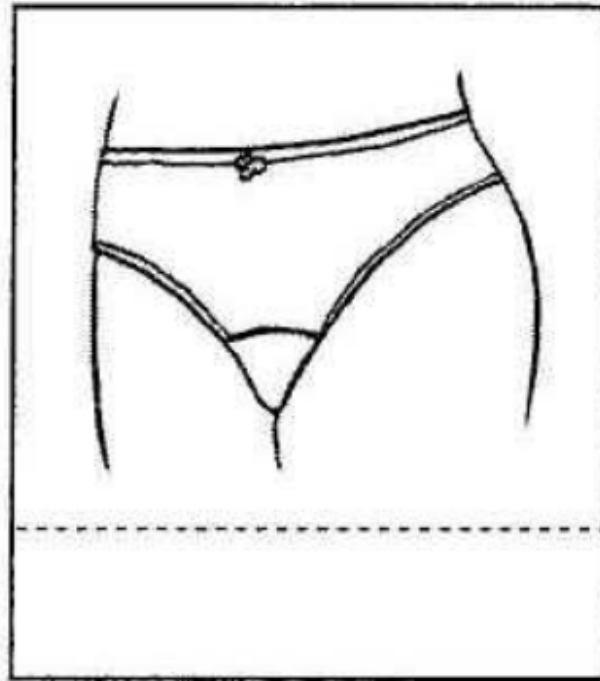

el sostenidor

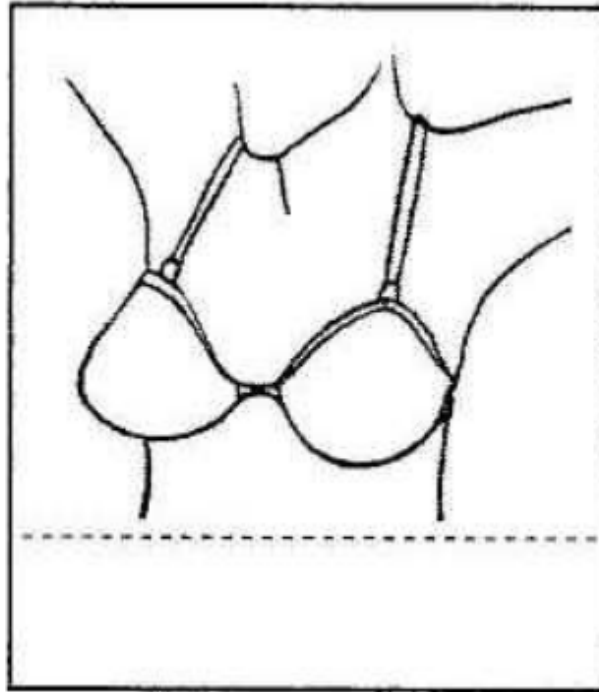

la samarreta

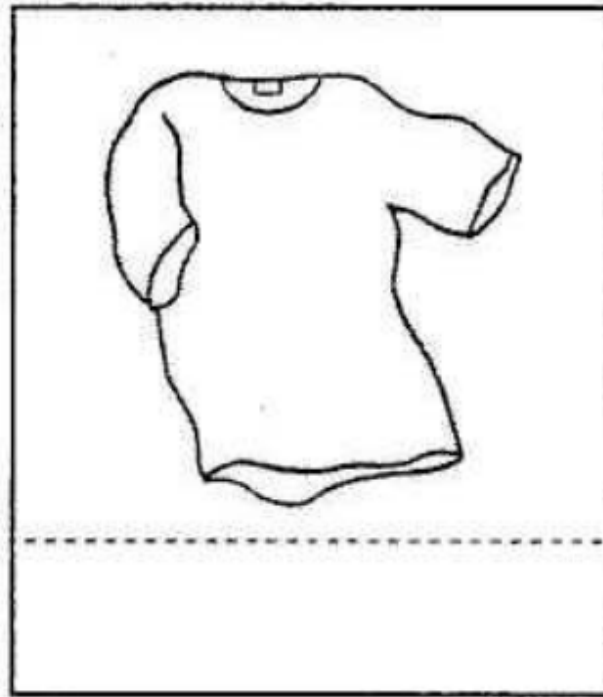

els mitjons

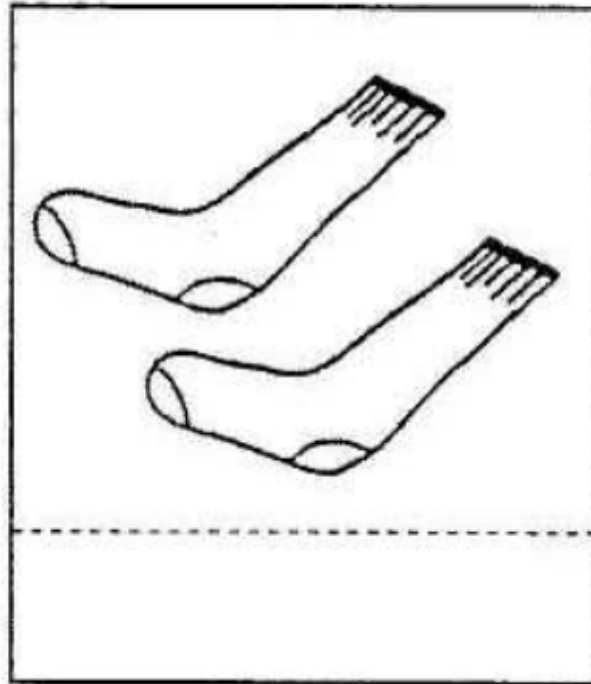

les mitges

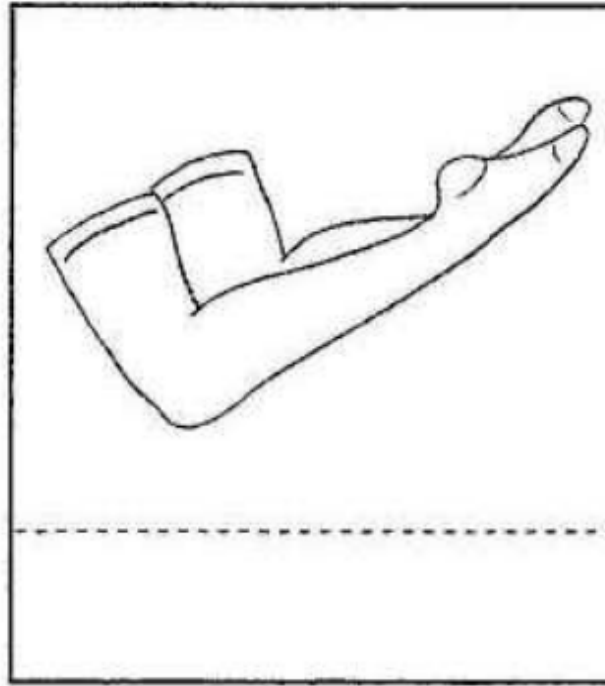

la camisa

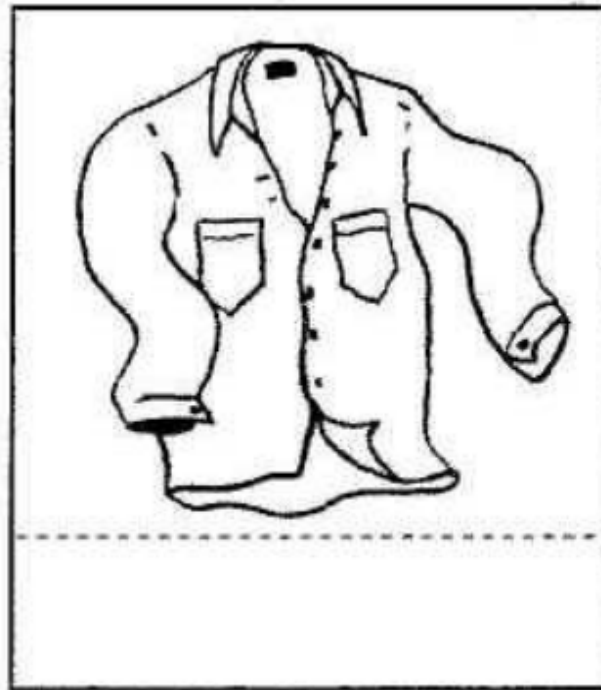

els botons

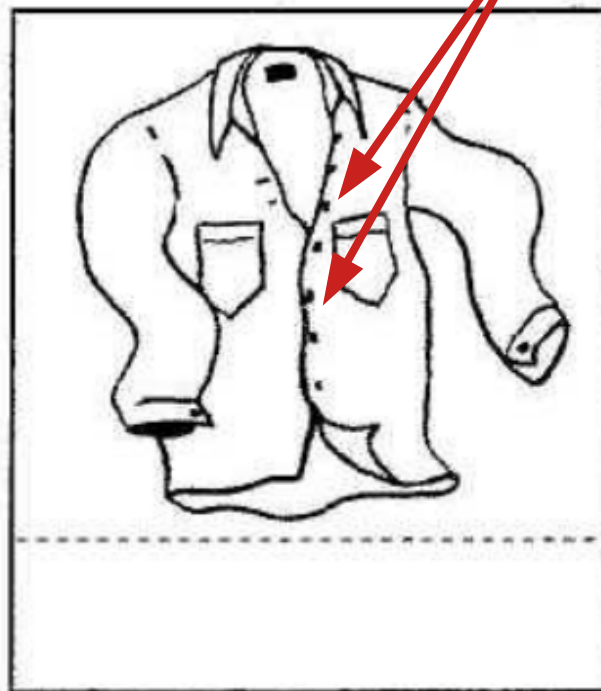

el coll

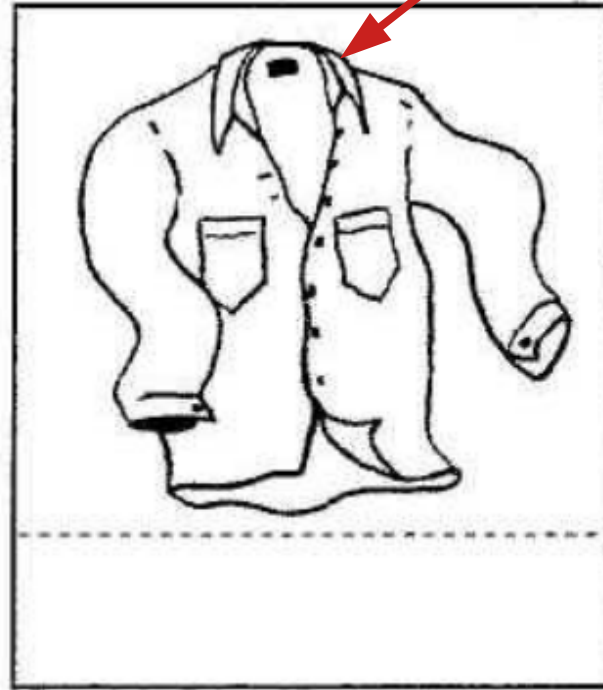

la màniga

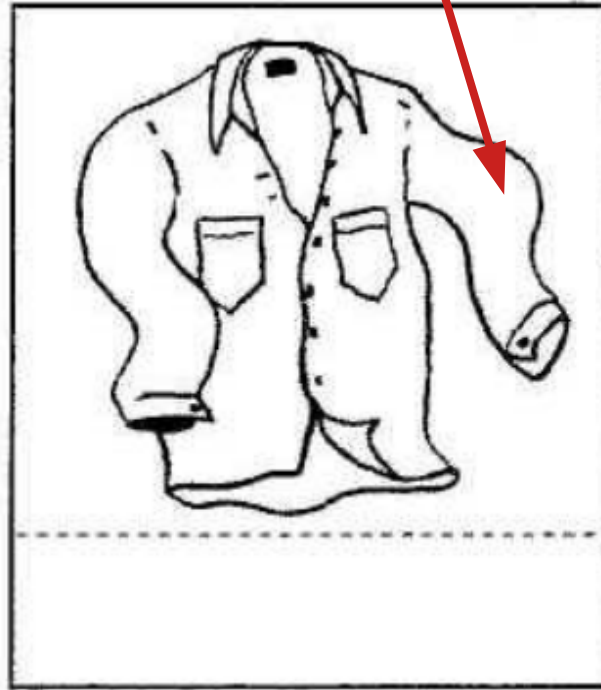

la rebeca o la jaqueta

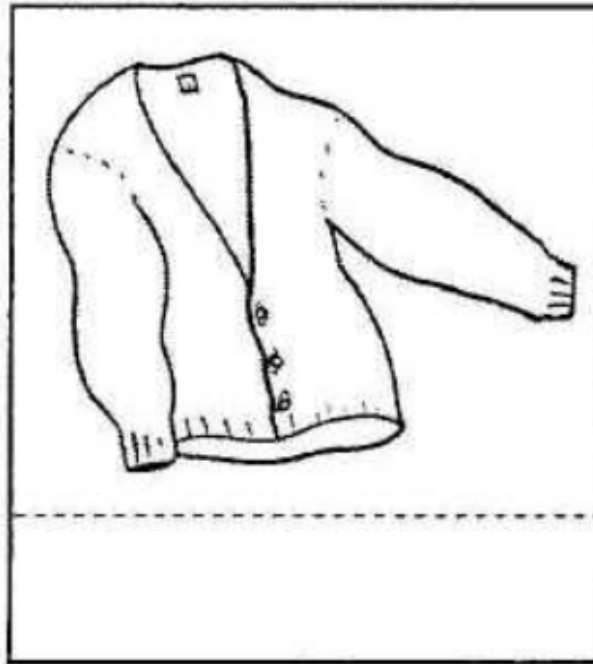

els pantalons

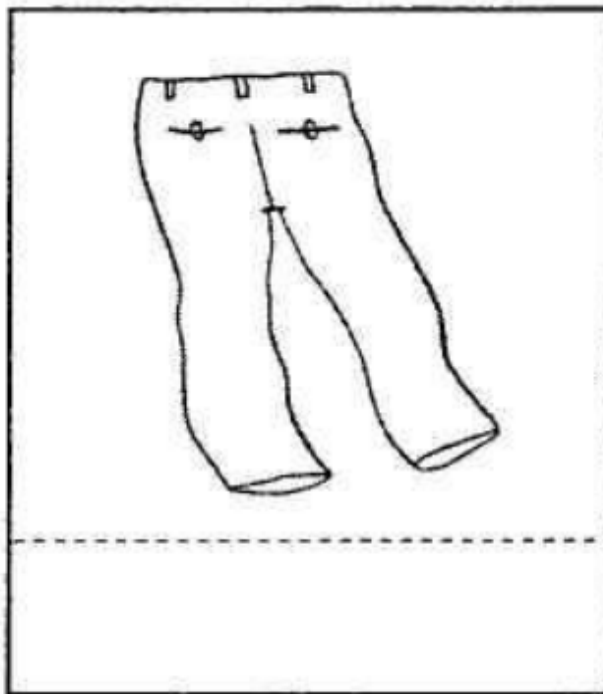

la butxaca
les butxaques

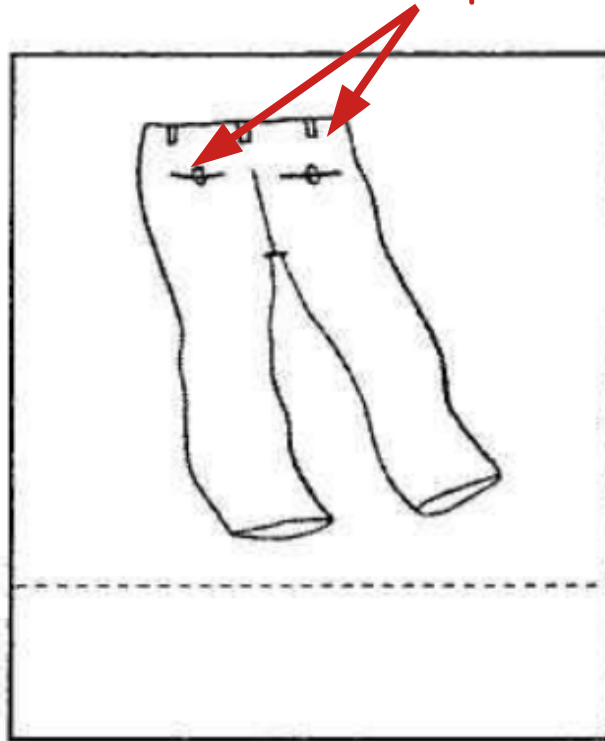

el cinturón

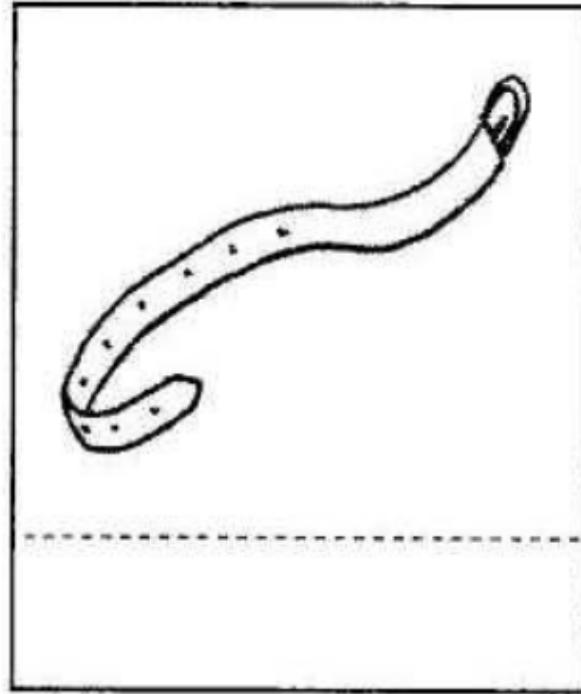

la sivella

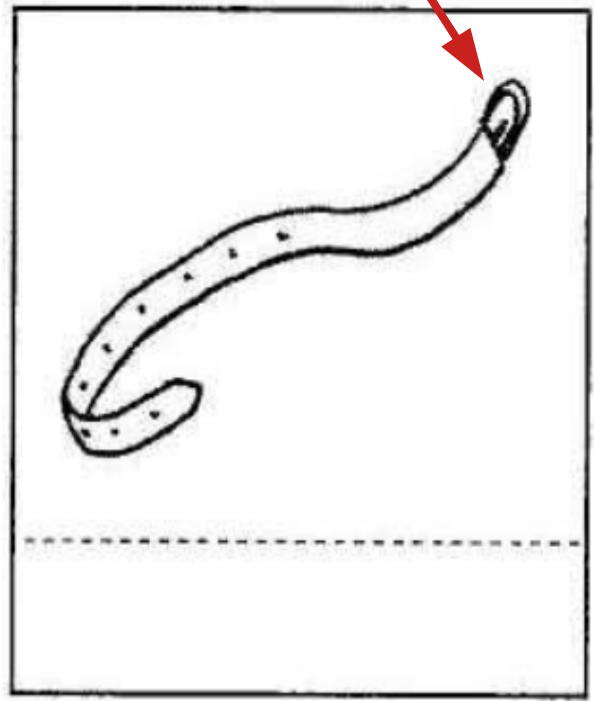

la faldilla

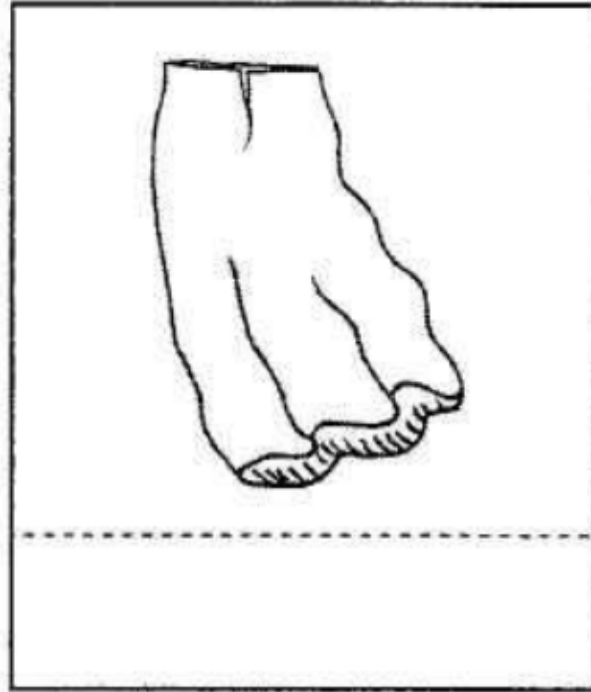

la cintura

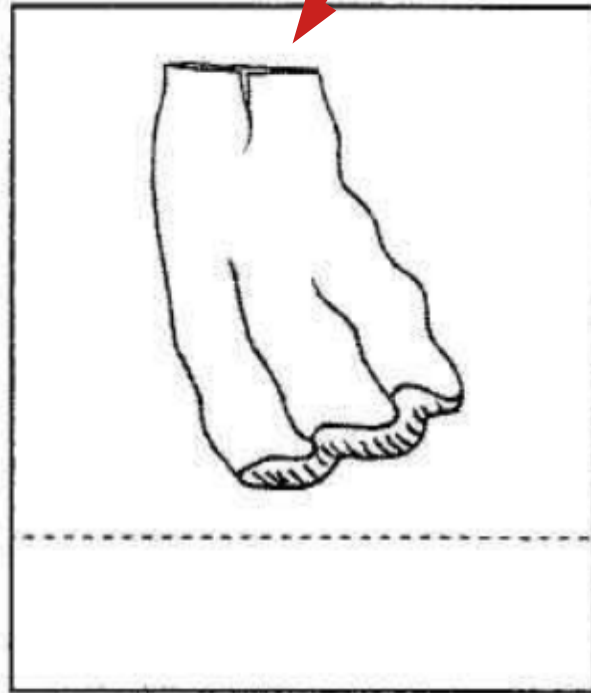

el jersey

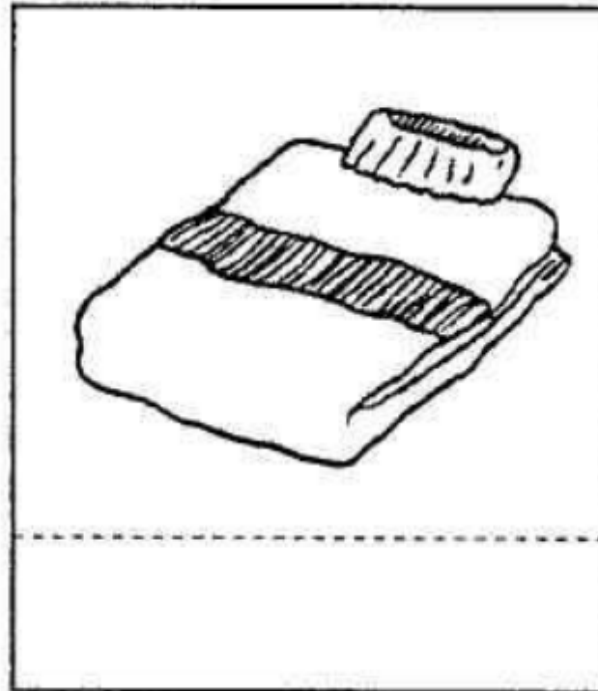

els guants

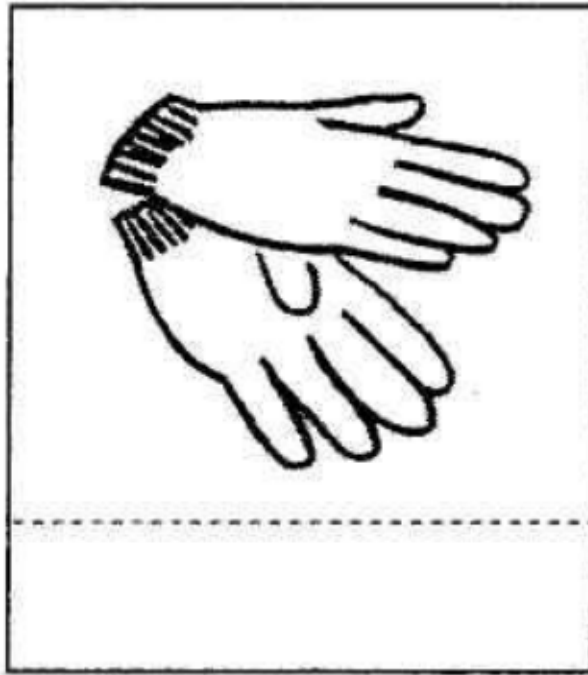

la bufanda

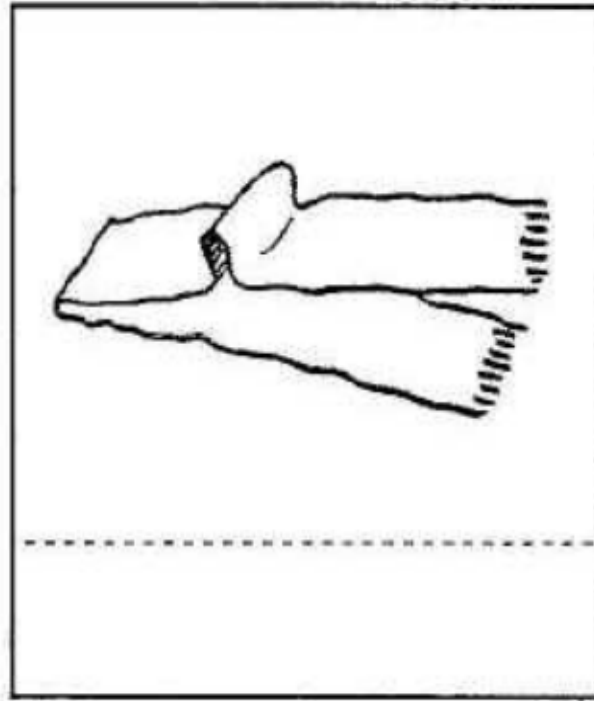

l'amorac

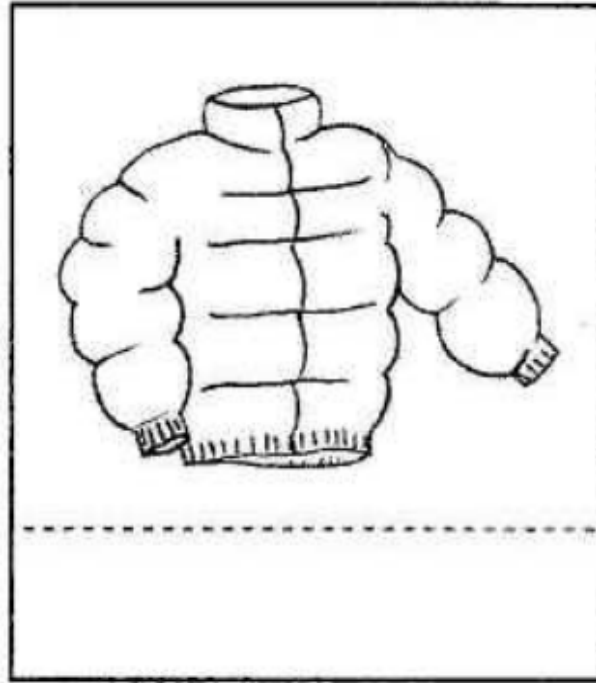

la cremallera

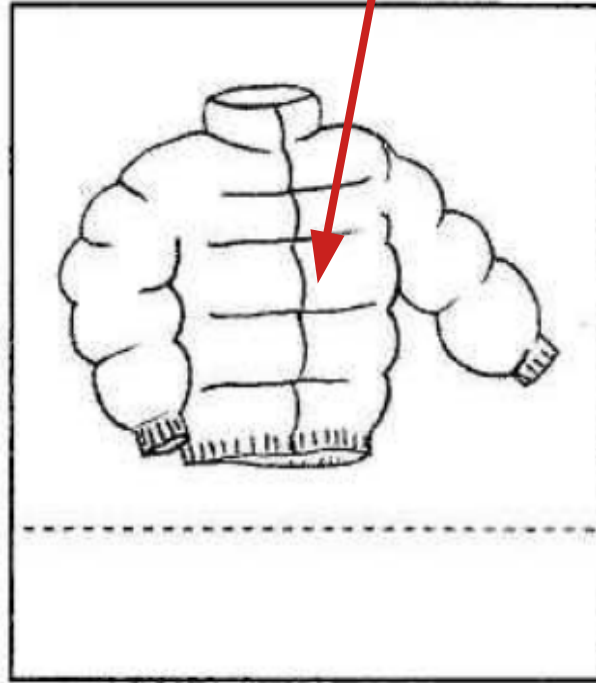

els punys

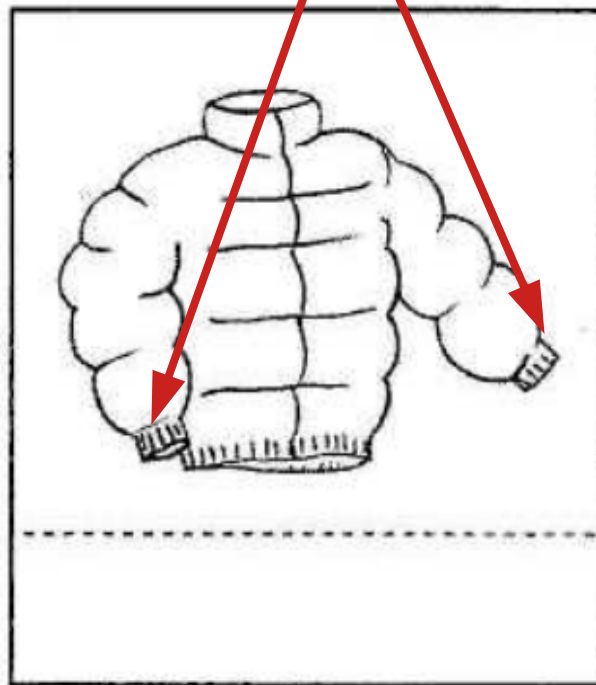

el vestit

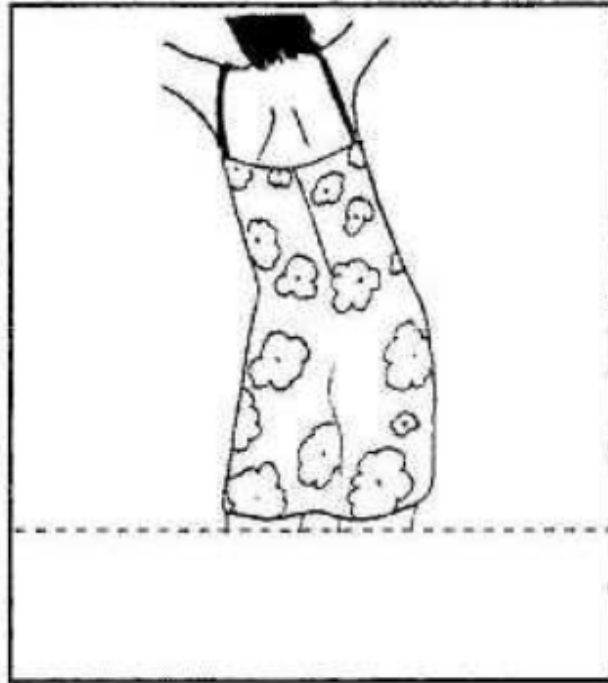

el banyador

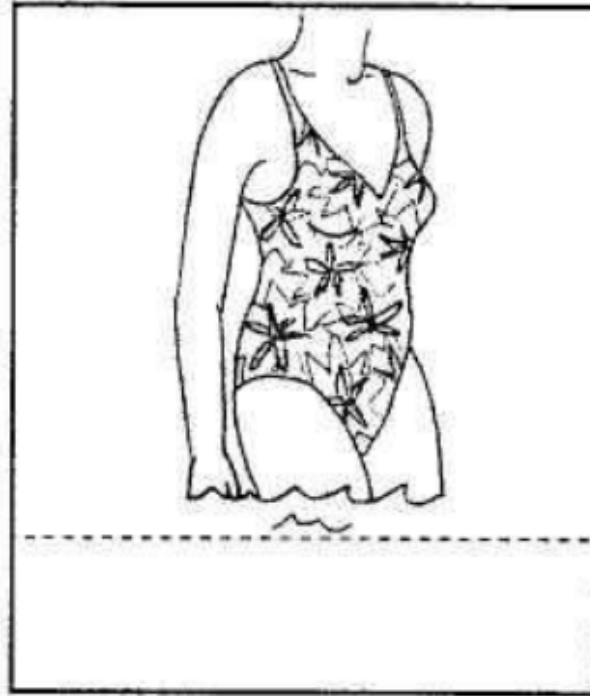

el sandall

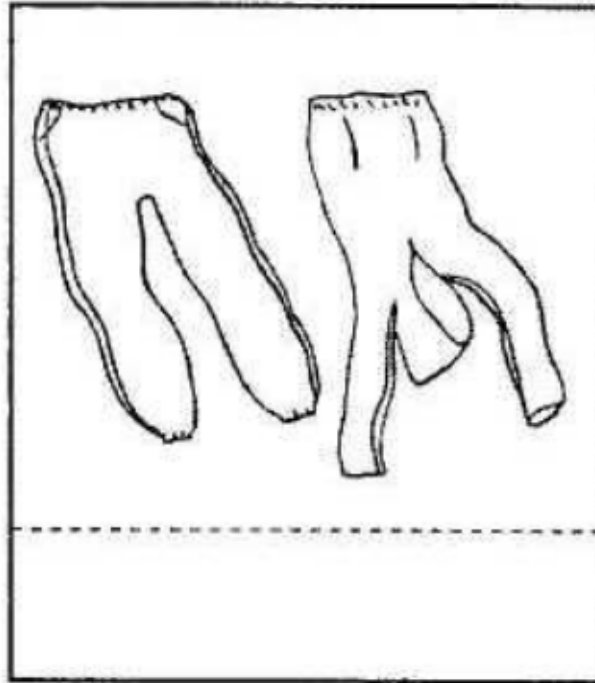

la caputxa

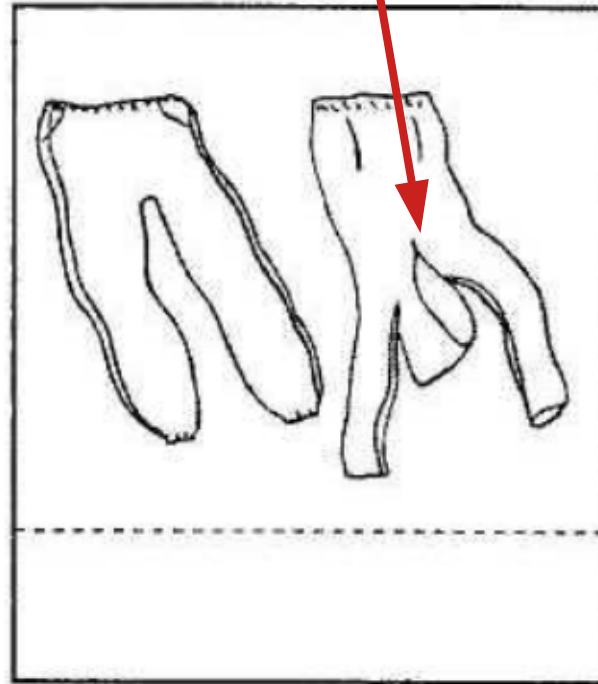

la gorra

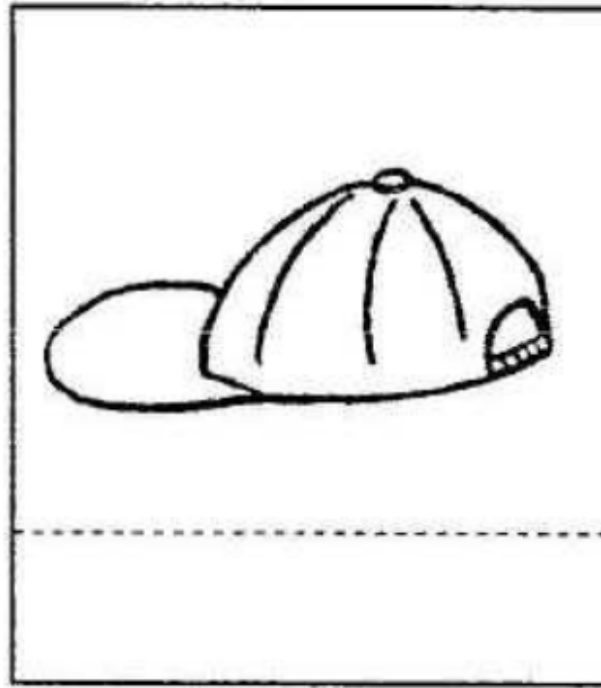

la visera

