

# COMENÇEM

## **Unitat 1: La classe**

**(Usuari bàsic A)**

**Pilar Arnáiz  
Gemma Carreras  
Fefa Gómez  
Rosa M. Via  
David Martínez  
(il·lustrador)**



Generalitat de Catalunya  
**Departament d'Educació**

**1. Observa:**

1. EL LLAPIS
2. LA GOMA
3. EL BOLÍGRAF
4. EL RETOLADOR
5. LA LLIBRETA
6. EL LLIBRE
7. L'ESTOIG
8. LA MAQUINETA
9. EL REGLE
10. LA MOTXILLA
11. LES TISORES

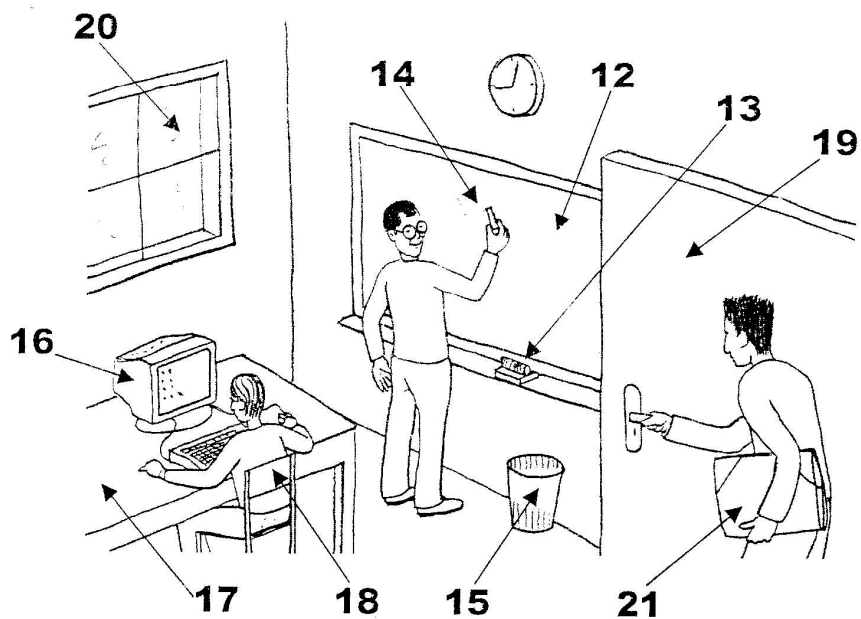
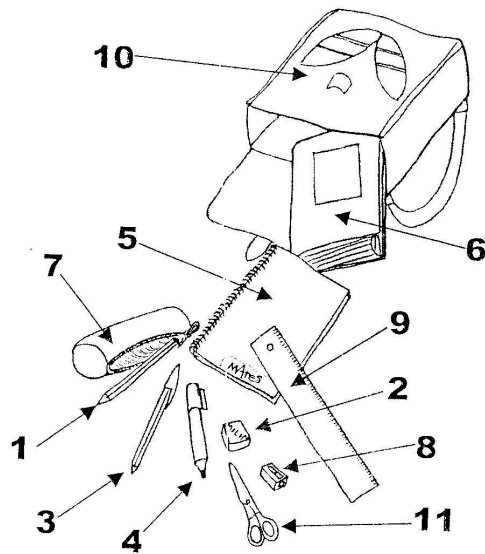

12. LA PISSARRA
13. L'ESBORRADOR
14. EL GUIX
15. LA PAPERERA
16. L'ORDINADOR

17. LA TAULA
18. LA CADIRA
19. LA PORTA
20. LA FINESTRA
21. LA CARPETA

**2. Completa:**

- |              |          |
|--------------|----------|
| 1. el llapis | 11. .... |
| 2. ....      | 12. .... |
| 3. ....      | 13. .... |
| 4. ....      | 14. .... |
| 5. ....      | 15. .... |
| 6. ....      | 16. .... |
| 7. ....      | 17. .... |
| 8. ....      | 18. .... |
| 9. ....      | 19. .... |
| 10. ....     | 20. .... |
|              | 21. .... |

**3. Busca 10 paraules relacionades amb la classe.**

E	R	P	L	L	A	P	I	S	T
T	C	A	D	I	R	A	P	A	F
O	R	D	I	N	A	D	O	R	G
P	P	I	S	S	A	R	R	A	M
E	S	B	O	R	R	A	D	O	R
S	G	O	M	A	B	A	L	C	D
F	J	E	R	E	G	L	E	Y	H
A	O	G	J	E	S	T	O	I	G
A	P	O	R	T	A	J	H	K	A
L	L	L	I	B	R	E	T	A	N

1. LLAPIS
2. ....
3. ....
4. ....
5. ....
6. ....
7. ....
8. ....
9. ....
10. ....

**4. Posa les vocals que falten.**

R		G	L		T		S		R		S
---	--	---	---	--	---	--	---	--	---	--	---

B		L		G	R		F	T			L	
---	--	---	--	---	---	--	---	---	--	--	---	--

M		Q			N		T		G		M	
---	--	---	--	--	---	--	---	--	---	--	---	--

5. Què és?



És una motxilla

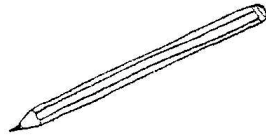

És un .....

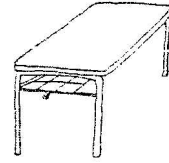

..... taula

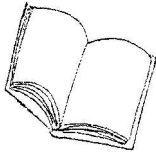

És un .....

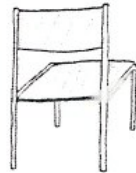

És una .....



..... pinzell

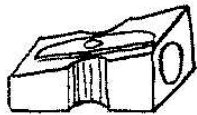

És .....

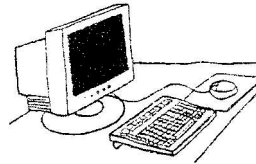

És .....



És una .....

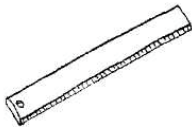

És un .....



És .....

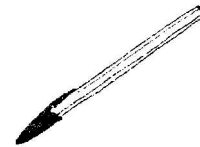

És .....

6. Completa:

UN / masculí	UNA / femení
.....	.....
.....	.....
.....	.....
.....	.....
.....	.....
.....	.....

7. Dibuixa i copia:

Gros o grossa

Una goma grossa

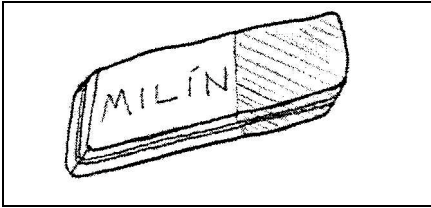

.....

Un llibre gros

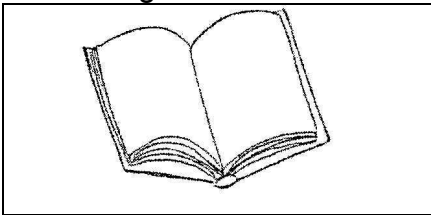

.....

Una taula grossa

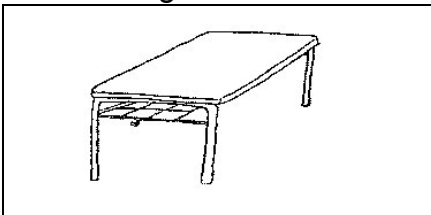

.....

Un estoig gros

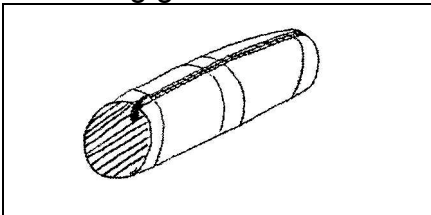

.....

Una llibreta grossa

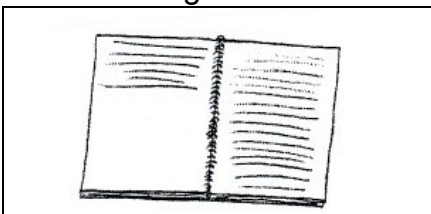

.....

Petit o petita

Una goma petita

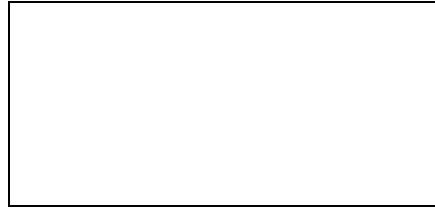

.....

Un llibre petit

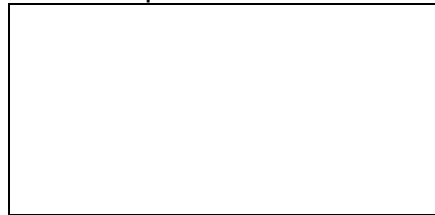

.....

Una taula petita

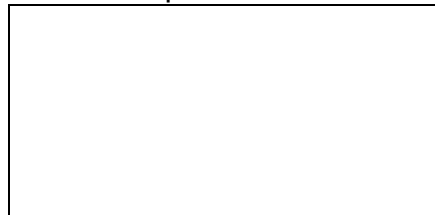

.....

Un estoig petit

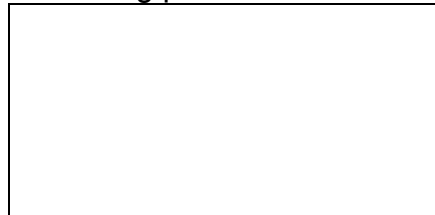

.....

Una llibreta petita

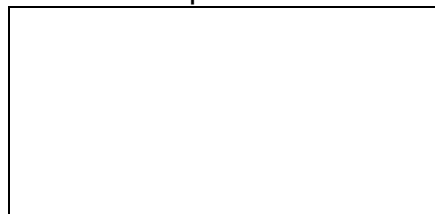

.....

**8. Relaciona i copia les frases:**

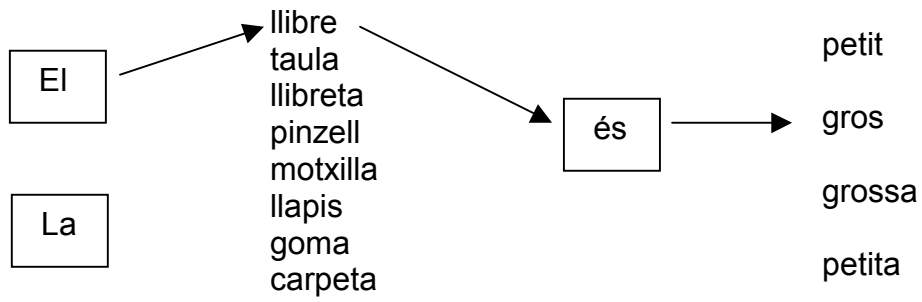

- El llibre és gros.

- .....
- .....
- .....
- .....
- .....
- .....
- .....
- .....

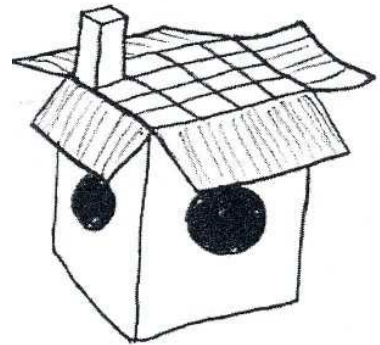

**9. Completa:**

**TAULA CADIRA MAPA PORTA PISSARRA  
ARMARI PÒSTER FINESTRA**

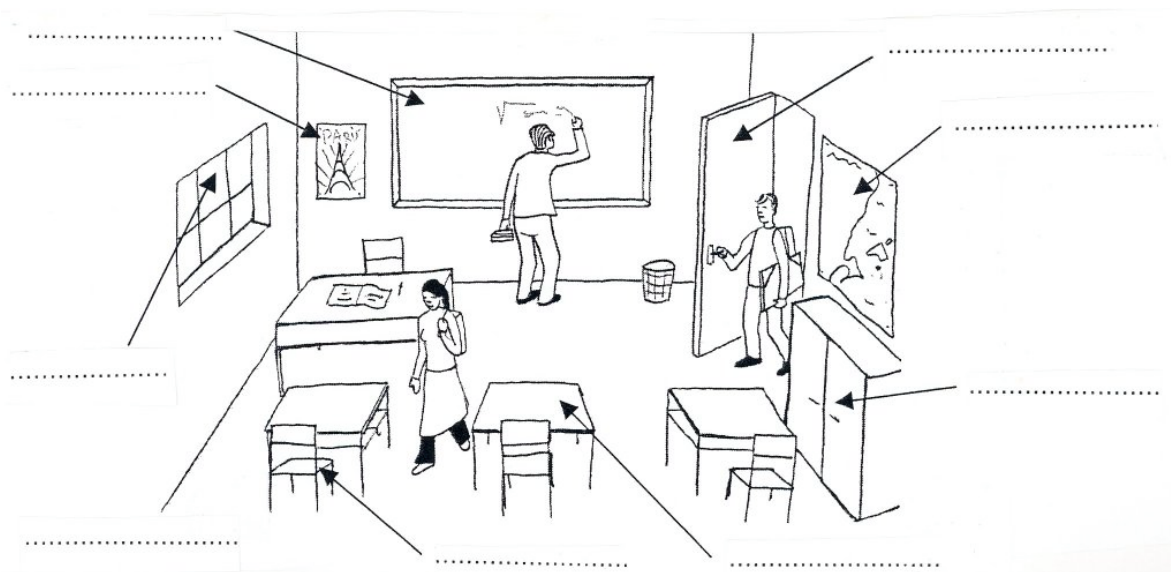

10. Omple:

UN	MOLTS
llibre	llibres
bolígraf	.....
pòster	.....
.....	estoigs
.....	esborradors
ordinador	.....
regle	.....
.....	armaris

11. Pinta:

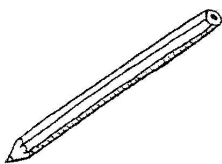

un llapis groc

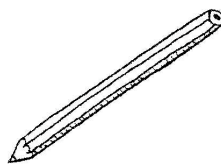

un llapis blau

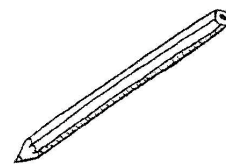

un llapis verd

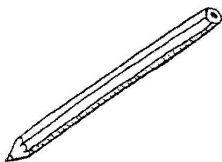

un llapis vermell

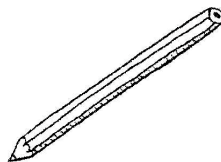

un llapis marró

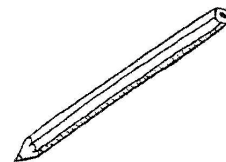

un llapis taronja

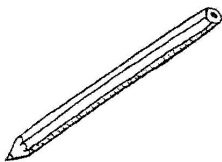

un llapis lila

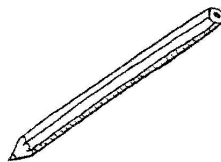

un llapis negre

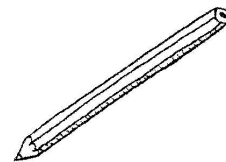

un llapis blanc

**12. Dibuixa, pinta i copia.**

Un retolador vermell

.....

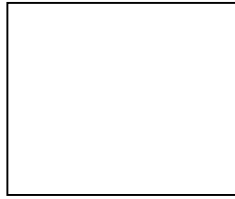

Un pinzell marró

.....



Un llapis negre

.....



Una motxilla vermella

.....

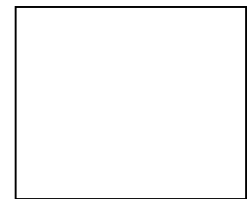

Un llibre groc

.....

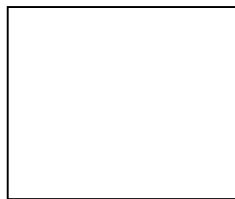

Un estoig blau

.....



Una maquineta verda

.....

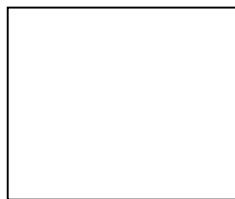

Una llibreta lila

.....

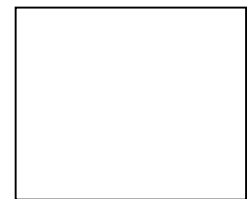

Unes tisores grogues

.....



Un llibre taronja

.....





13. A l'estoig portem:

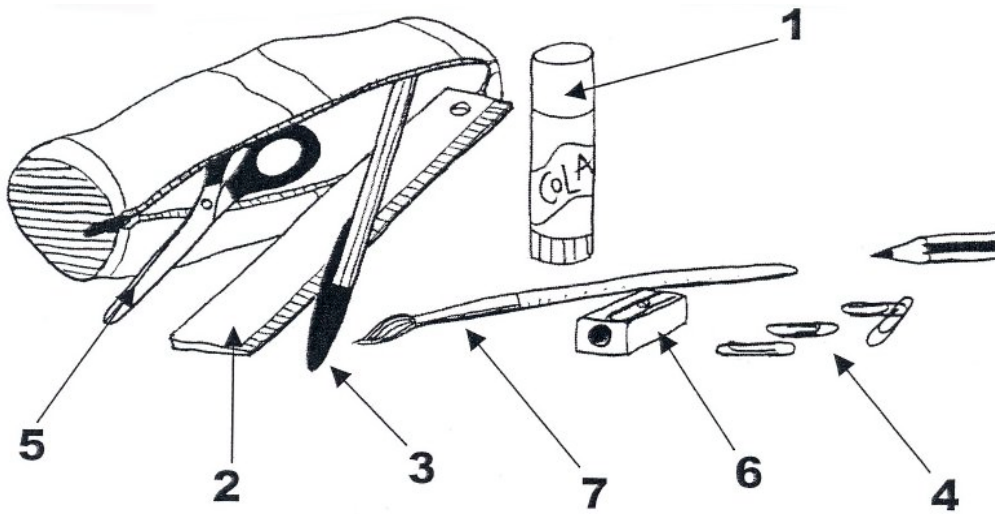

- 1. UN TUB DE COLA
- 2. UN REGLE
- 3. UN BOLÍGRAF
- 4. UNS CLIPS

- 5. UNES TISORES
- 6. UNA MAQUINETA
- 7. UN PINZELL

- A l'estoig portem un tub de cola
- A l'estoig portem.....
- .....
- .....
- .....
- .....
- .....

14. Escriu el nom:

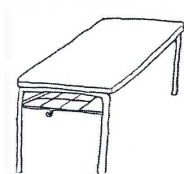

.....

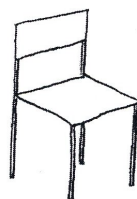

.....

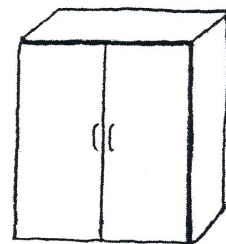

.....

15. Completa:

escriu pinta retalla dibuixa parla

JOAN

KARIM

SANDRA



LAURA

PAU

- En Pau .....
- La Sandra .....
- En Joan .....
- En Karim .....
- La Laura .....

16. Relaciona:

tisores	→	retallar
llapis		pintar
pinzell		escriure
llapis de colors		esborrar
goma		enganxar
guix		
retoladors		
cola		

**17. Completa:**

llibre - llibreta - llapis - tisores retolador - diccionari - goma

- Retallem amb les .....
- Escrivim a la .....
- Llegim .....
- Pintem .....
- Consultem el .....
- Escrivim amb el .....
- Esborrem amb la .....

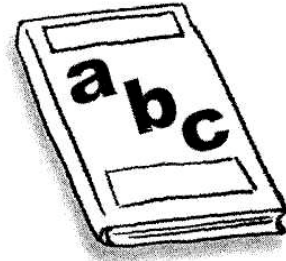

**18. Copia les frases anteriors.**

- Retallem amb les.....
- .....
- .....
- .....
- .....
- .....
- .....
- .....

**19. Ordena les lletres:**

APMA

M.....

RESTÒP

P.....

GLEER

R.....

DORLATORE

R.....

GIXU

G.....

ESOIGT

E.....

LLIERB

L.....

ORNADIORD

O.....

ROPAT

P.....

FIESNTRA

F.....

PIRRASSA

P.....

PAREPERA

P.....

**20. Mots encreuats.**

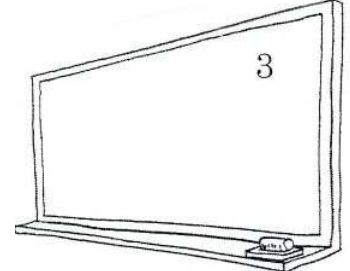
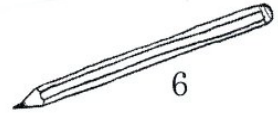
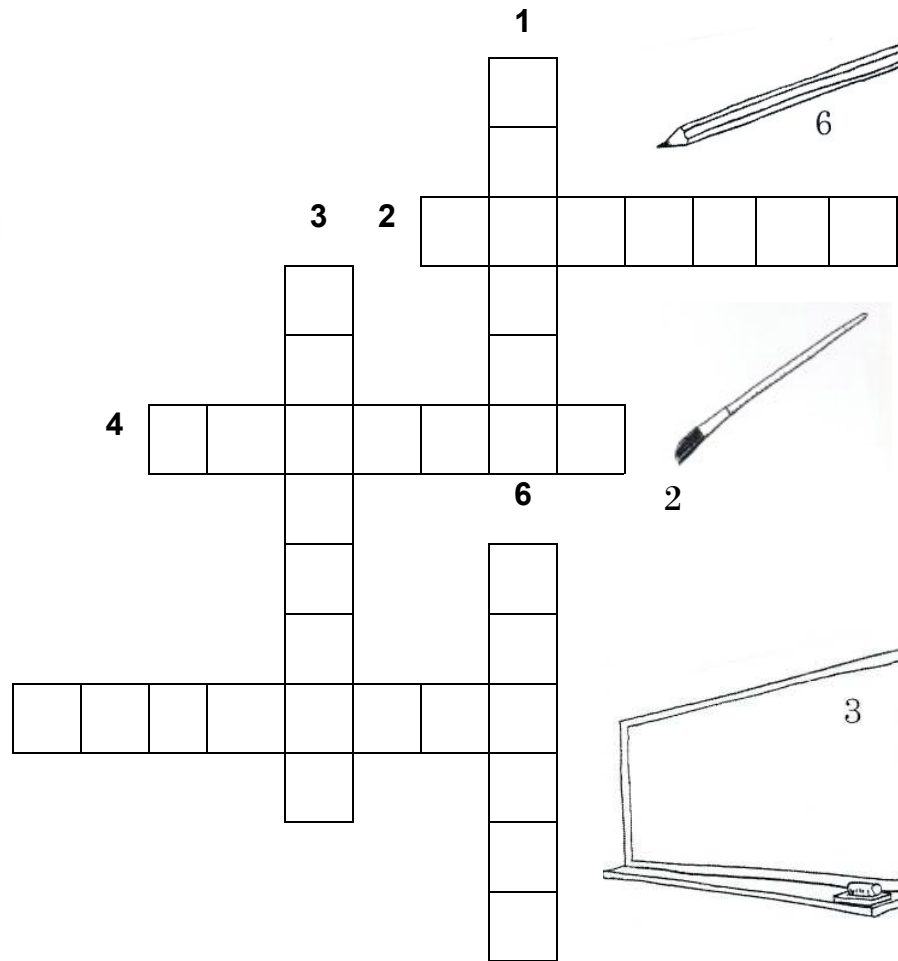
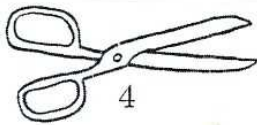
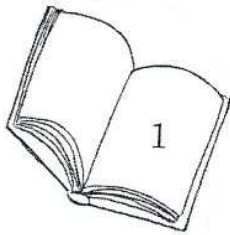
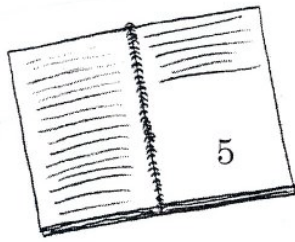

**21. Encercla els noms de les coses de la classe:**

el llapis	la cullera	la boca	la piscina	el peu	
l'arbre	el llibre	el cotxe	la motxilla	l'autocar	la cama
el semàfor	les tisores	el pinzell	la moto	el bolígraf	
el gos	l'estoig	la llibreta	la cadira	el tigre	
la taula	l'esborrador	l'ordinador	el dit		
el mapa	la cola	la goma	la paperera	el nas	
la llet	la patata	el te	el regle	el foli	

**22. Posa l'article:**

**el - la - l' - els - les**

- |                  |                  |                 |                |
|------------------|------------------|-----------------|----------------|
| ..... paperera   | ..... maquineta  | ..... estoig    | ..... taula    |
| ..... armari     | ..... cadira     | ..... cola      | ..... pinzell  |
| ..... guix       | ..... tisores    | ..... maleta    | ..... regle    |
| ..... retoladors | ..... llibre     | ..... bolígrafs | ..... mapa     |
| ..... ordinador  | ..... esborrador | ..... goma      | ..... llibreta |

**23. Completa:**

<b>UNA</b>	<b>MOLTES</b>
cadira	cadires
goma	.....
.....	maquinetes
.....	maletes
finestra	.....
porta	.....
pissarra	.....
.....	papereres

**24. Escriu els noms:**

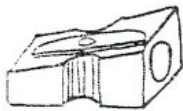

.....



.....

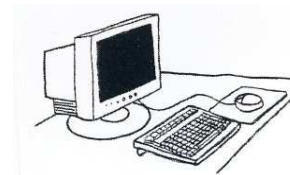

.....

**25. Dibuixa i copia:**

Una motxilla



.....

Una carpeta



.....

Un llibre

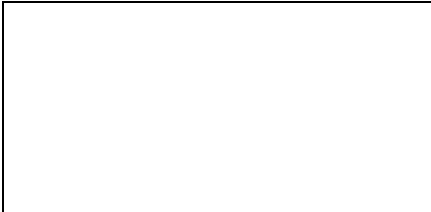

.....

Un full / un foli

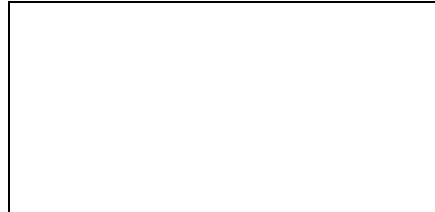

.....

Una cadira

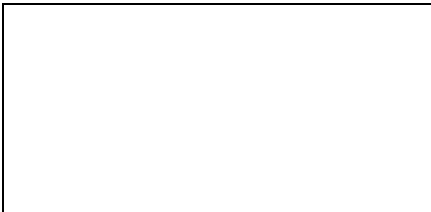

.....

Una pissarra

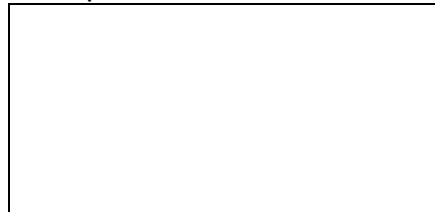

.....

Una paperera



.....

Un armari

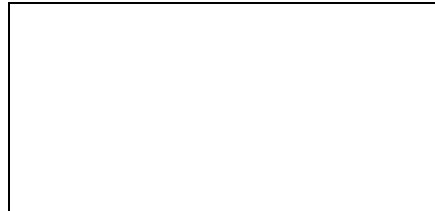

.....

Una llibreta

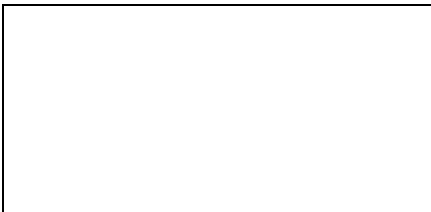

.....

Unes tisores

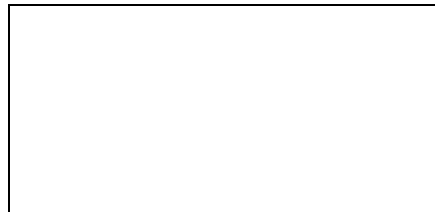

.....

**26. Completa:**

- ◆ Jo pinto una cara.
- ◆ Tu pintes una .....
- ◆ Ell pinta .....
- ◆ Nosaltres pintem .....
- ◆ Vosaltres pinteu .....
- ◆ Ells pinten .....

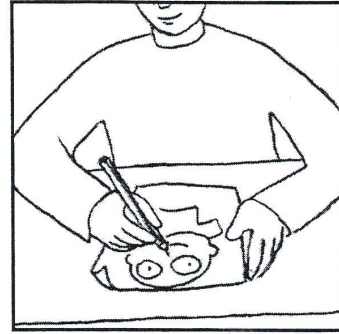

- ◆ Jo pinto una classe.
- ◆ Tu pintes .....
- ◆ Ella .....
- ◆ Nosaltres.....
- ◆ Vosaltres.....
- ◆ Ells.....

- ◆ Jo retallo amb les tisores.
- ◆ Tu retalles amb .....
- ◆ Ella retalla .....
- ◆ Nosaltres .....
- ◆ Vosaltres .....
- ◆ Elles .....



- ◆ Jo enganxo un paper.
- ◆ Tu enganxes .....
- ◆ Ell .....
- ◆ Nosaltres .....
- ◆ Vosaltres .....
- ◆ Ells .....

**27. Escriu 10 noms d'objectes de la classe que tinguin la a :**

.....	.....
.....	.....
.....	.....
.....	.....
.....	.....

**28. Separa les paraules i escriu les frases correctament:**

{	Escrivim / a / la / pissarra / amb / el / guix.
{	Escrivim a la pissarra amb el guix.
{	Enganxo els fulls amb un clip.
{	.....
{	Porto els llibres a la motxilla.
{	.....
{	Busco el país a la mapa.
{	.....
{	Treballo amb l'ordinador.
{	.....

**29. Escriu frases:**

- La Fàtima retalla amb les tisores.
- .....
- .....
- .....
- .....
- .....
- .....
- .....
- .....



**30. Observa i escriu el nom dels números:**

1. u	3. tres	5. cinc	7. set	9. nou
2. dos	4. quatre	6. sis	8. vuit	10. deu

8 .....      3 .....      1 .....      5 .....

9 .....      7 .....      6 .....      10 .....

2 .....      4 .....      7 .....      3 .....

**18. Retalla i enganxa dibuixos o fotografies de coses de la classe. Escriu el nom o fes frases.**

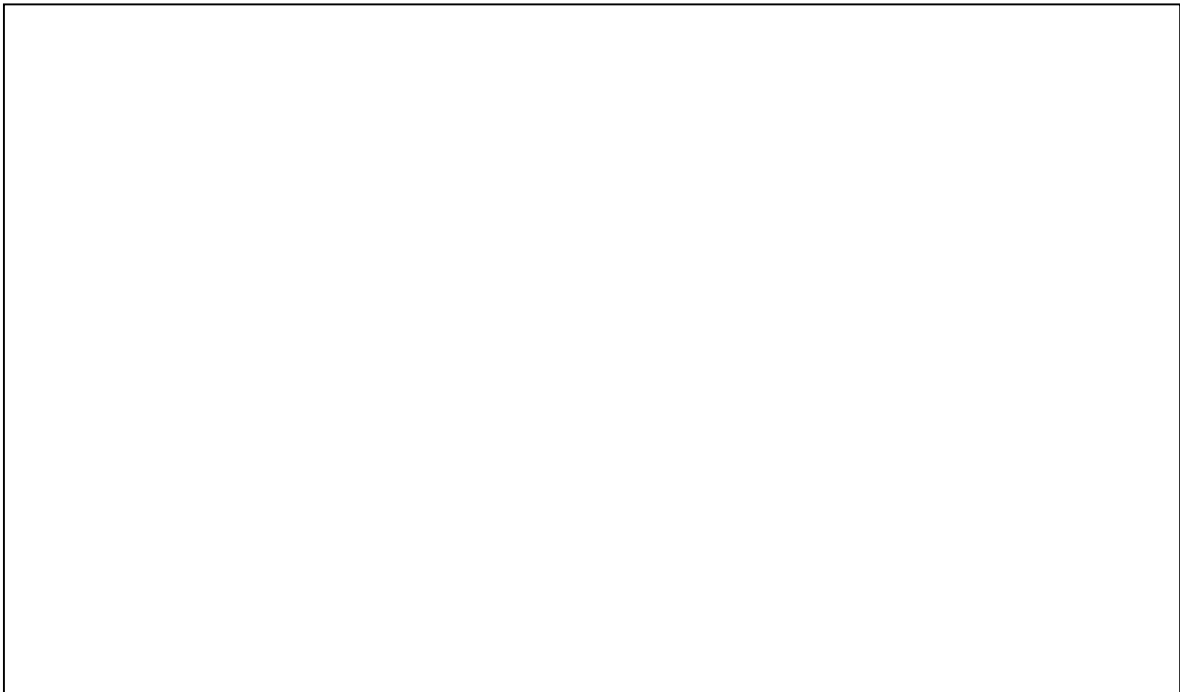

- .....
- .....
- .....
- .....
- .....
- .....
- .....
- .....
- .....